

Polyacetal (POM)

DURACON®

M270-44

CF2001/CD3068

Standard

General Properties of M270-44

table1-1 General Properties (ISO)

Item	Unit	Test Method	Standard
			M270-44
			High Flow, Fast Molding Cycle
Color			CF2001/CD3068
ISO(JIS)quality-of-the-material display:		ISO11469 (JIS K6999)	>POM<
Density	g/cm ³	ISO 1183	1.41
Water absorption (23°C,24hrs,1mmt)	%	ISO 62	0.5
MFR (190°C、 2.16kg)	g/10min	ISO 1133	27
MVR (190°C、 2.16kg)	cm ³ /10min	ISO 1133	23
Tensile strength	MPa	ISO 527-1,2	63
Strain at break	%	ISO 527-1,2	30 ¹
Tensile modulus	MPa	ISO 527-1,2	2,800
Flexural strength	MPa	ISO 178	88
Flexural modulus	MPa	ISO 178	2,550
Charpy notched impact strength (23°C)	kJ/m ²	ISO 179/1eA	5.3
Temperature of deflection under load (1.8MPa)	°C	ISO 75-1,2	100
Coefficient of linear thermal expansion (23 - 55°C、 Flow direction)	x10 ⁻⁵ /°C	Our standard	11
Coefficient of linear thermal expansion (23 - 55°C、 Transverse direction)	x10 ⁻⁵ /°C	Our standard	11
Electric strength (3mmt)	kV/mm	IEC 60243-1	19
Volume resistivity	Ω·cm	IEC 60093	1 × 10 ¹⁴
Surface resistivity	Ω	IEC 60093	1 × 10 ¹⁶
Volume resistivity (Our standard)	Ω·cm		-
Surface resistivity (Our standard)	Ω		-
Mold Shrinkage (60×60×2mmt, Flow direction, Cavity Pressure 60 MPa)	%	ISO 294-4	2.2
Mold Shrinkage (60×60×2mmt, Transverse direction, Cavity Pressure 60 MPa)	%	ISO 294-4	2.2
Rockwell hardness	M(Scale)	ISO2039-2	80
Specific wear amount (Thrust, vs C-Steel, material side, pressure 0.49MPa, 30cm/s)	x10 ⁻³ mm ³ /(N·km)	JIS K7218	-
Specific wear amount (Thrust, vs C-Steel, steel side, pressure 0.49MPa, 30cm/s)	x10 ⁻³ mm ³ /(N·km)	JIS K7218	-
Coefficient of Dynamic Friction (Thrust, vs C-Steel, pressure 0.49MPa, 30cm/s)		JIS K7218	-

Item	Unit	Test Method	Standard
			M270-44
			High Flow, Fast Molding Cycle
Specific wear amount (Thrust, vs C-Steel, material side, pressure 0.98MPa, 30cm/s)	$\times 10^{-3} \text{mm}^3/(\text{N} \cdot \text{km})$	JIS K7218	0.30
Specific wear amount (Thrust, vs C-Steel, steel side, pressure 0.98MPa, 30cm/s)	$\times 10^{-3} \text{mm}^3/(\text{N} \cdot \text{km})$	JIS K7218	0.01>
Coefficient of Dynamic Friction (Thrust, vs C-Steel, pressure 0.98MPa, 30cm/s)		JIS K7218	0.40
Specific wear amount (Thrust, vs M90-44, material side, pressure 0.06MPa, 15cm/s)	$\times 10^{-3} \text{mm}^3/(\text{N} \cdot \text{km})$	JIS K7218	-
Specific wear amount (Thrust, vs M90-44, M90-44 side, pressure 0.06MPa, 15cm/s)	$\times 10^{-3} \text{mm}^3/(\text{N} \cdot \text{km})$	JIS K7218	-
Coefficient of Dynamic Friction (Thrust, vs M90-44, pressure 0.06MPa, 15cm/s)		JIS K7218	0.37
Flammability		UL94	HB
The yellow card File No.			E45034
Appropriate List number of Ministerial Ordinance for Export Trade Control			Item 16 of Appendix -1

*1) Nominal strain at break

All figures in the table are the typical values of the material and not the minimum values of the material specifications.

Introduction

Duracon® POM is a representative engineering plastics material that possesses numerous excellent properties, together with good flowability when molding. It is used in a wide variety of applications centered on functional parts in various industrial, applications, and its areas of application are steadily becoming more diverse.

From a processing perspective and a perspective

of the required performance in molded parts, there are various suitable grades and series available.

Here, we introduce **the M90-44 series**, which features enhanced heat stability and reduced mold deposits when molding. **The M90-44 series** includes the high viscosity type **M25-44**, the general purpose intermediate viscosity type **M90-44**, the high flow types **M140-44** and **M270-44**, and the ultra-high flow type **M450-44**.

1. Performance characteristics of -44 series

1.1 Prevention of deposit formation at electrical contacts

For the previous grades M90-02 and -04, M90-12 and -14, deposits can be formed in parts in the proximity of electrical contacts under certain high temperature conditions. This can result in component failure. In such cases, grades in the -44 series can solve these problems.

1.2 Short- and medium-term light fastness and weatherability

For applications where a high level of weatherability is necessary over extended periods outdoors, the results of outdoor irradiation tests over a relatively short time are shown in table 1-1 for natural colored grades.

Table 1-1 Light fastness of DURACON® POMM90-44

(Outdoor exposure of 30 days)

Item		DURACON® M90-44
Tensile strength (30d) Retention (%)		100
Tensile elongation (30d) Retention (%)		73
Discoloration Δ E	(8d)	1.9
	(19d)	2.2
	(30d)	2.8

Note: Discoloration is determined from the equation shown below using a hunter-type color meter with Δ L, Δ a and Δ b defined as values of L, a and b after exposure respectively.

$$\Delta E = \sqrt{(\Delta L)^2 + (\Delta a)^2 + (\Delta b)^2}$$

1.3 Long-term characteristics

1.3.1 Heat stability at elevated temperature

The **-44 series** has superior thermal stability under elevated temperatures. **Figure 1-1** shows the results of tests for property changes caused by high temperature heat aging. As the tests indicate,

the **-44 series** has superior heat stability. In addition, for this level of heat aging, the color change of the **-44 series** is of the order of M90-02, and there is, therefore, no problems.

The **UL(Underwriters Laboratories Inc.)**

temperature index on the basis of the long-term heat degradation experiments from these tests is shown in **Table 1-2**. As is shown, the **-44 series** is approved at 5-10 deg C higher than the -02series.

Table 2-2 ULapproved temperatures for DURACON® POM (Unit:°C)

Grade	Electrical	Mechanical	
		With impact	Without impact
DURACON® M90-44	110	95	110

Fig. 1-1 Chage in tensile strength characteristics through heat aging(at 120°C and 140°C)

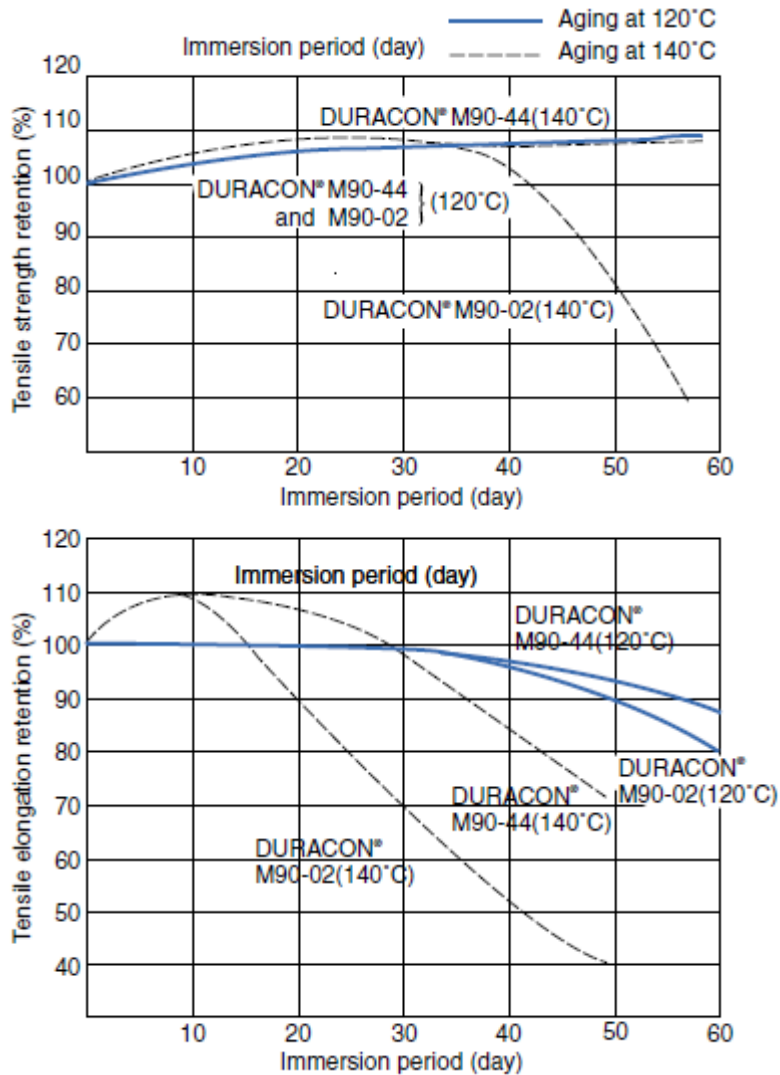

The changes in mechanical properties due to heat aging are as shown in **Table 1-3**. While elongation and Izod impact strength degrade 20-30% over 12 months of treatment, tensile strength and flexural strength do not fall, and there is also no difference for **M90-44**.

As shown in the data below, compared with **M270-44** and **M90-44**, one can consider the physical data to be almost the same, although in

terms of toughness and long term properties, in particular creep at high temperature, there is a fear that properties will degrade somewhat relative to **M90-44**. This point should be noted. In applications where toughness and high temperature creep characteristics are of particular concern, we recommend using **M25-44** and **M90-44**.

Table 1-3 Changes in mechanical properties of DURACON® POM M270-44 from heat aging
(in atmospheric air, 82°C, 12 months)

Property		Unit	DURACON® M270-44		DURACON® M90-44	
			Initial	After 12 months	Initial	After 12 months
Tensile property	Yield strength	MPa	60	62	60	61
	Elongation at yield	%	12	10	12	10
	Break strength	MPa	54	55	54	56
	Elongation at break	%	40	28	60	38
	Modulus of elasticity	MPa	2.820	2.820	2.820	2.820
Flexural property	Flexural strength	MPa	96	98	96	97
	Flexural modulus	MPa	2.580	2.580	2.580	2.580
Izod impact strength (notched)		J/m	52	43	63	48

1.3.2 Hot Water Resistance

figure 1-2 indicates changes in tensile strength as an example of property changes upon immersion in 95°C water.

Fig. 1-2 Hot water resistance of DURACON® POM M90-44
(Property retention ratio in 95°C hot water)

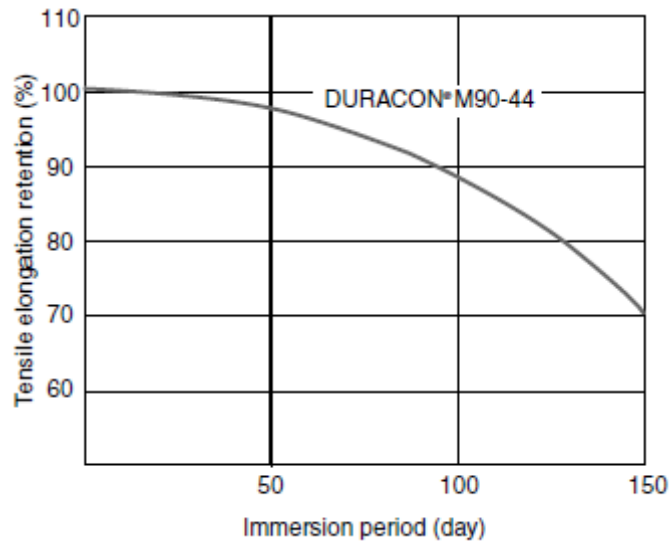
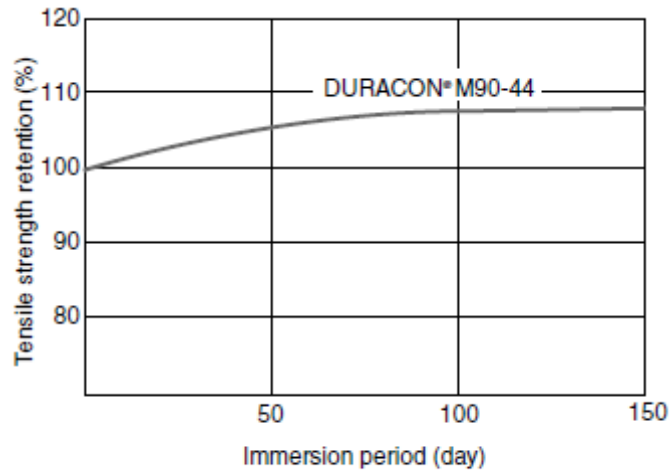

2. Processing characteristics of -44 series

2. Flow characteristics

shown in **Table 2-1**. In addition, **Figure 2-1** shows a comparison of **M90-44** and **M140-44**.

Results of bar flow length tests using a bar flow length mold and sample thickness of 2mm are

Table 2-1 Bar flow length using bar flow length test mold
(Unit:mm)

injection pressure MPa	DURACON® M90-44
49.0	240
73.5	323
98.0	404
122.5	490

Processing parameters

Material temperature : 200°C
 Mold temp : 80°C
 Injection speed : 50mm/sec
 Mold cavity : Bar flow test mold halves, Thickness of molded products 2mm
 Gate : Width 20mm, Thickness 200

Fig. 2-1 Bar flow lengths for DURACON® POM M140-44 and M90-44

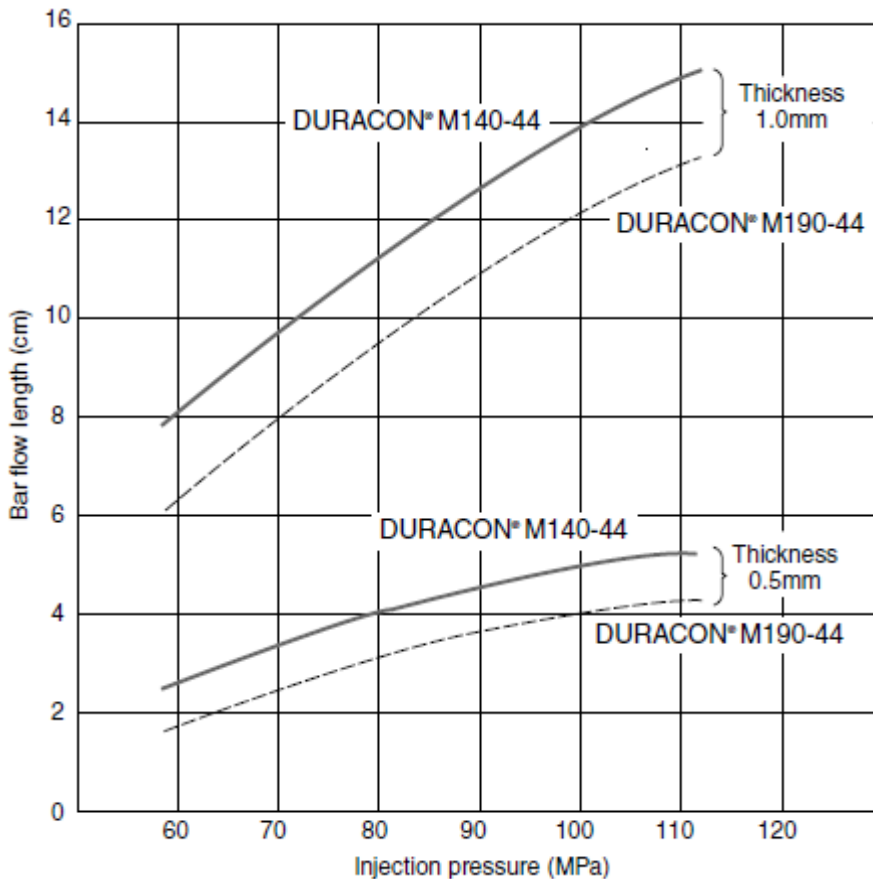

Processing parameters

Cylinder temp. : 190°C
 Gate : 2×2×0.5mm
 Mold temp. : 80°C
 Cycle : Injection 12s/
 cooling 10s
 Injection speed : 33mm/sec

The flow characteristics of M270-44 are shown in **Table 2-2** and **Figure 2-2**. Compared with the general purpose type M90, the flowability of **M270-44** is vastly improved, and this is the main characteristic of the grade. This is characteristic, as explained below, contributes to the shortening of cycle times, making possible cost-effective molding. In addition, compared with M90, sprue

and runner cross sections can be reduced by almost half, thereby enabling considerable reduction of the amount of scrap. Moreover, **M270-44** generally does not generate flow marks, so a major characteristic of the grade is that an excellent surface finish can be achieved with a relatively low mold temperature.

Table 3-2 Bar flow length of DURACON® POM M270-44 and M90-44

Thickness (mm)	Material Injection pressure MPa	M270-44		M90-44	
		Flow length (cm)	Flow ratio*	Flow length (cm)	Flow ratio*
1	61	15.7	143	11.0	100
	73	18.0	141	12.8	100
	85	20.1	141	14.3	100
	98	22.3	139	16.0	100
	Average	—	141	—	100
2	61	42.2	148	28.5	100
	73	48.2	146	33.1	100
	85	54.6	146	37.4	100
	98	60.0	145	41.3	100
	Average	—	146	—	100

Processing parameters

Material temp. : 195-200°C
 Mold temp. : 80°C
 Injection speed : 50mm/sec
 Cycle : Inj. 12s, Cooling 10s, Total 37s
 Mold : 20W×1,550L×(1 and 2t)mm
 Gate : 12×6×3mm

*Flow ratio: For all conditions, the flow length ratio of M270-44 with the flow length of M90-44 is 100.

Fig. 3-2 Bar flow length of DURACON® POM M270-44 and M90-44

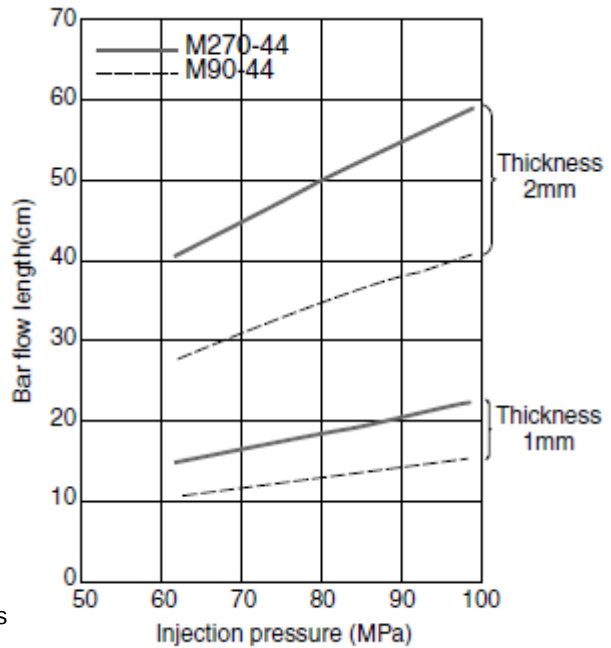

Processing parameters

Material temp. : 195-200°C
 Mold temp. : 80°C
 Injection speed : 50mm/sec
 Cycle : Inj. 12s, Cooling 10s, Total 37s
 Mold : 20W×1,550L×(1 and 2t)mm
 Gate : 12×6×3mm

The main characteristic of M450-44 is its vastly superior flowability compared with M90-44 and M270-44. Therefore, it can be readily applied to thin wall molding, and there is also a tendency for parts to have little residual stress. In addition, cycle times can be shortened and sprue and runner cross sections reduced, so the scrap recycling rate can be reduced. These factors bring advantages from an economic perspective. Moreover, compared with M90-44, flow mark formation is generally small, so therefore a relatively superior surface finish can be achieved.

Figures 2-3 and 2-4 compare the flowability of M450-44 with other grades at a thickness of 2mm. When comparing bar flow lengths, generally speaking M450-44 is considered to be roughly 30% longer than M270-44, and 90-100% longer than M90-44.

In addition, Tables 2-5 and 2-6 show comparisons of bar flow lengths with M270-44 for thin-wall thicknesses of 0.2mm and 0.4mm. In thin-wall cases, the flow length of M450-44 is approximately 10% longer than M270-44, thus indicating M450-44's high flow characteristics.

Fig. 2-3 Flowability at 2 mm wall thickness
(Mold temperature: 80°C)

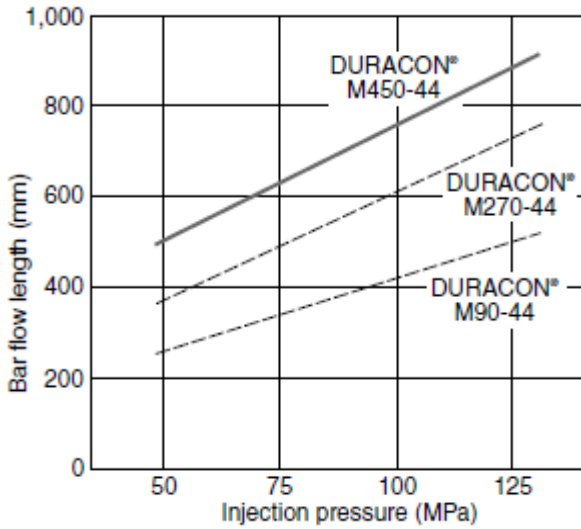

Fig. 2-4 Flowability at 2 mm wall thickness
(Mold temperature: 40°C)

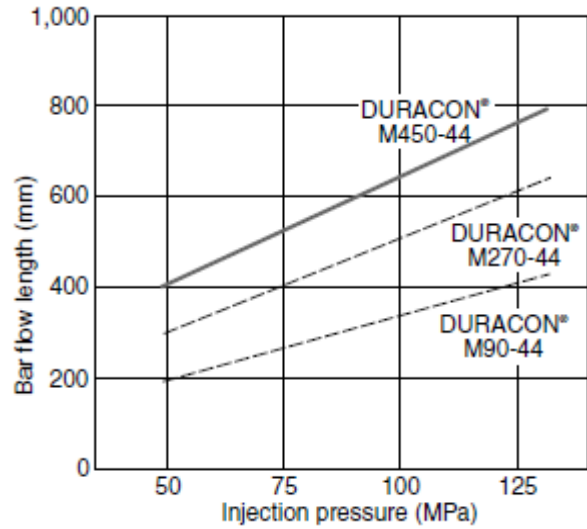

Fig. 2-5 Flowability in case of thin wall
(Mold temperature: 80°C)

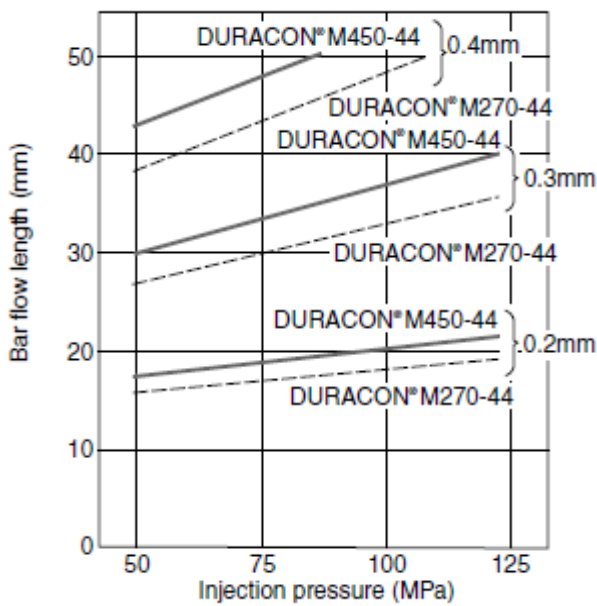
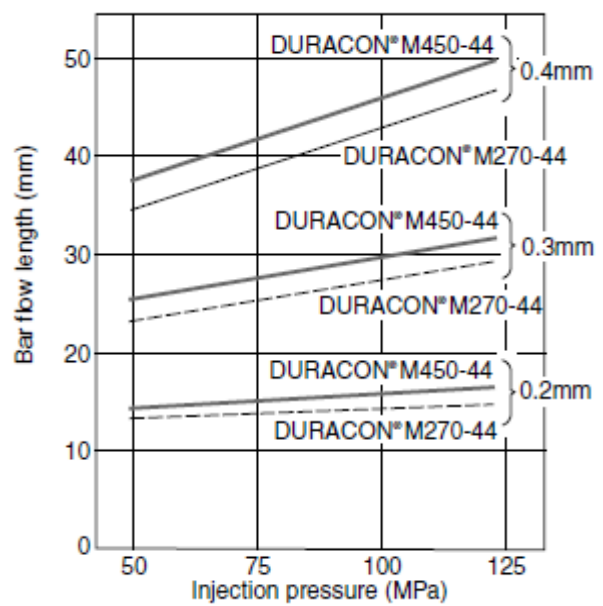

Fig. 2-6 Flowability in case of thin wall
(Mold temperature: 40°C)



Processing parameters Material temp. : 185~190°C
 Mold temp. : 80, 40°C
 Injection speed : 67mm/sec

2.2 Mold shrinkage ratio

Table 2-3 shows a comparison of mold shrinkage ratios for sample thickness' of 1, 2, and 3 mm for **M90-44**. **M90-44** exhibits almost the same mold shrinkage as M90-02, while slightly lower mold shrinkage anisotropy can be expected of **M90-44**.

The mold shrinkage ratio for **M140-44** is shown in **Figure 2-7**, while that for **M270-44** is shown in **Figures 2-8** and **2-9**. One can see that it is acceptable to design molds as for **M90-44**. Mold shrinkage for **M450-44** is shown in **Tables 2-4**, **2-10**, and **2-11**.

Table 2-3 DURACON® POMM90-44 mold shrinkage
(Unit : %)

Molded product thickness	Flow direction	DURACON® M90-44		
		Pressure MPa		
		58.8	68.6	78.4
1mm	Perpendicular to flow (//)		2.09	1.72
	Parallel to flow (⊥)		1.90	1.65
	//-⊥		0.19	0.07
2mm	Perpendicular to flow (//)	1.89	1.65	
	Parallel to flow (⊥)	1.84	1.74	
	//-⊥	-0.02	-0.03	
3mm	Perpendicular to flow (//)	1.91	1.82	
	Parallel to flow (⊥)	1.95	1.86	
	//-⊥	-0.04	-0.04	

Processing parameters

Material temperature : 200°C
 Mold temperature : 80°C
 Injection speed : 25mm/s
 Mold cavity : 120×120×1~3mm
 Gate : Side gate in one location at the center

Fig. 2-7 DURACON® POMM140-44 mold shrinkage

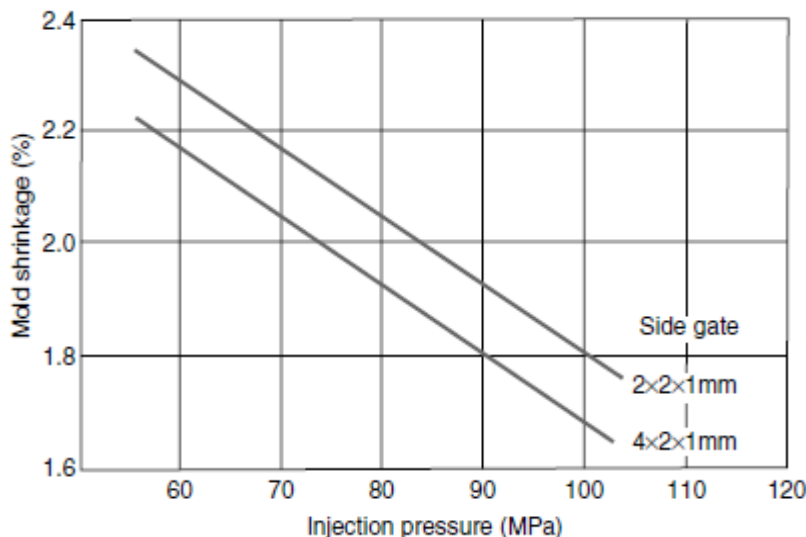

Processing parameters

Material temp. : 190°C
 Mold temp. : 80°C
 Injection speed : 17mm/sec
 Thickness of molded piece: 1mm

Fig. 3-8 DURACON® POM M270-44 mold shrinkage ratio
 (Effects of sample thickness and gate size)

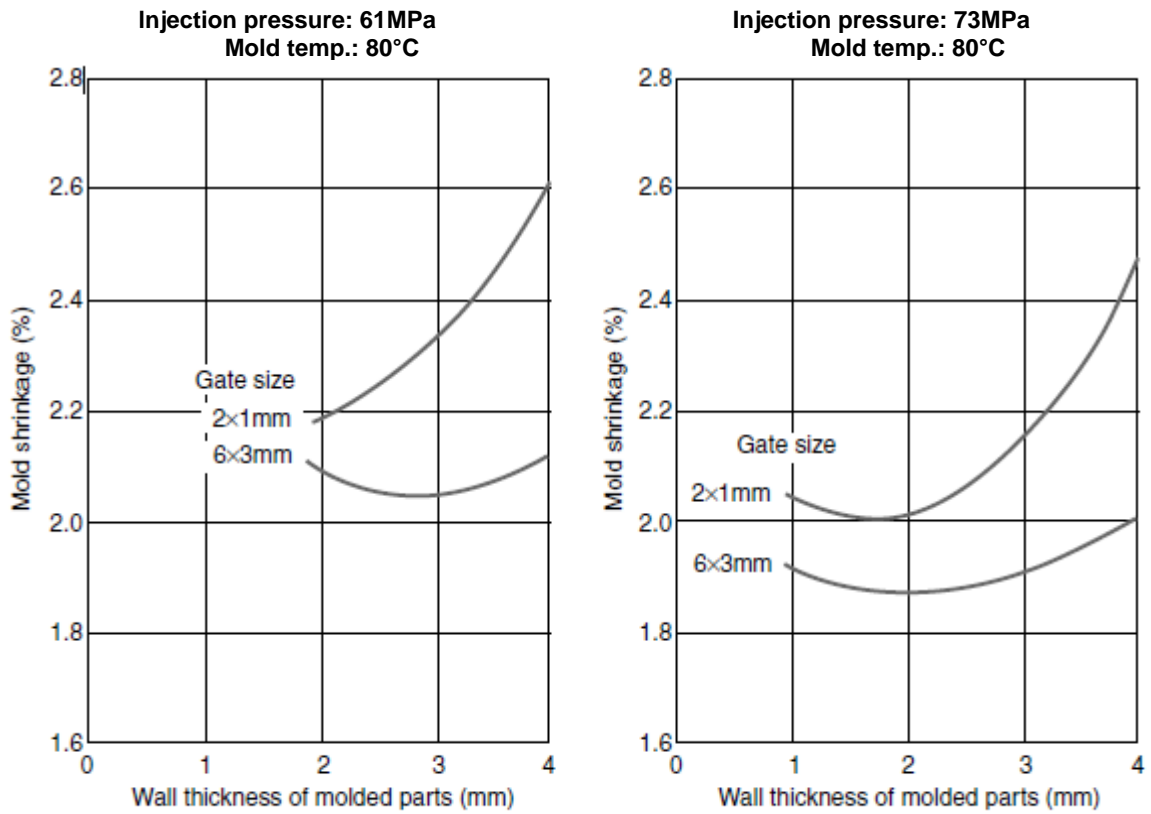

Processing parameters

Material temp. : 185-200°C
 Injection speed : 33mm/sec
 Cycle : 1mm 2mm 3mm 4mm
 Injection : 15s 20s 25s 35s
 Cooling : 10s 15s 20s 25s
 Total cycle : 35s 45s 55s 70s
 Mold : 120· 120· (2, 3, 4mmt)
 100· 100· 1mmt
 Gate : 2· 1, 6· 3mm, each having a double side gate.

Fig. 2-9 DURACON® POMM270-44 mold shrinkage ratio
 (Effects of injection pressure and mold temperature)

(1) Size of molded parts: 100· 10mm.
 1mm thick

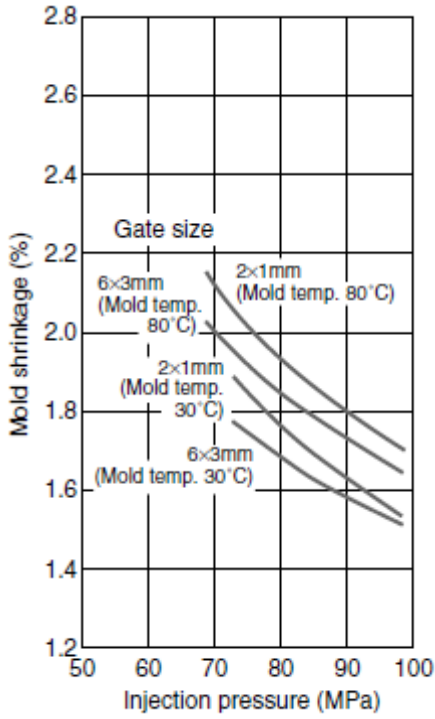

(2) Size of molded parts: 120· 12mm.
 2mm thick

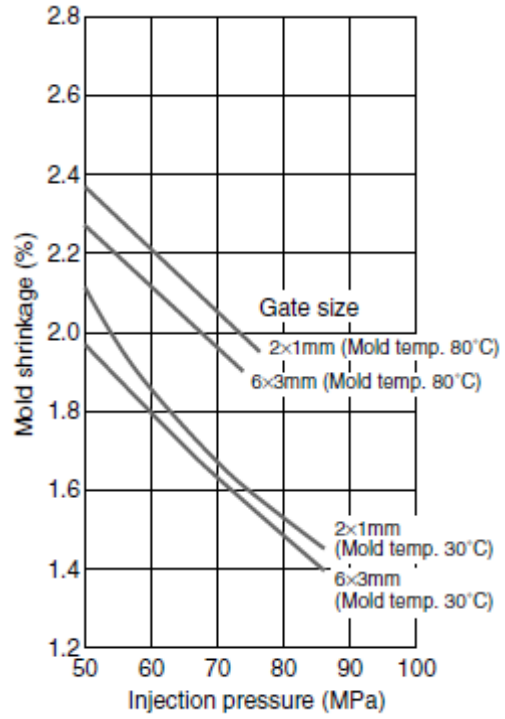

(3) Size of molded parts: 120· 12mm.
 3mm thick

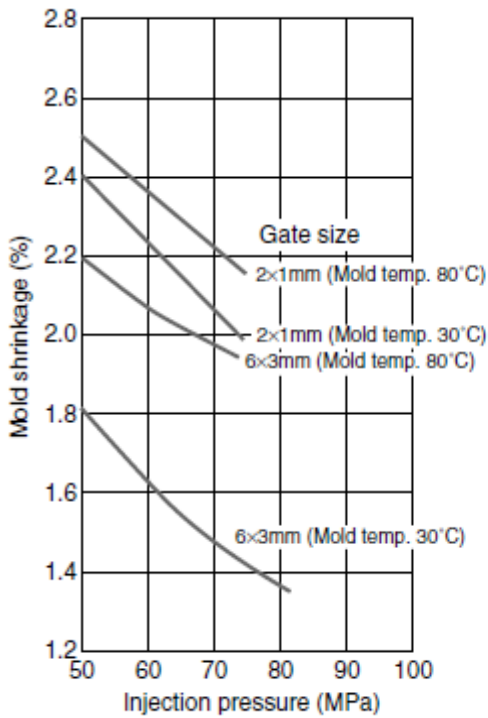

(4) Size of molded parts: 120· 12mm.
 4mm thick

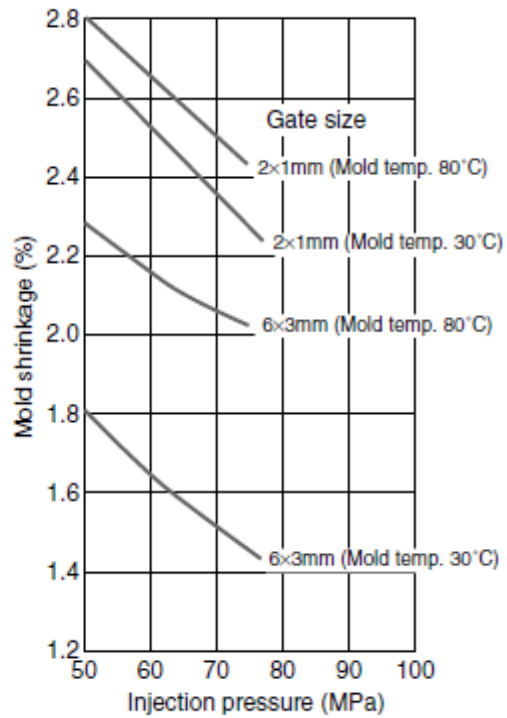

Table 2-4 DURACON® POM M450-44 mold shrinkage ratio

Mold temp. Injection pressure Thickness (mm)	80°C		40°C	
	MPa		MPa	
	49.0	68.6	69.0	68.6
2	2.2	1.8	1.9	1.4
3	2.2	1.8	1.8	1.4

Fig. 2-10 DURACON® POM M450-44 mold shrinkage ratio (2mmt)

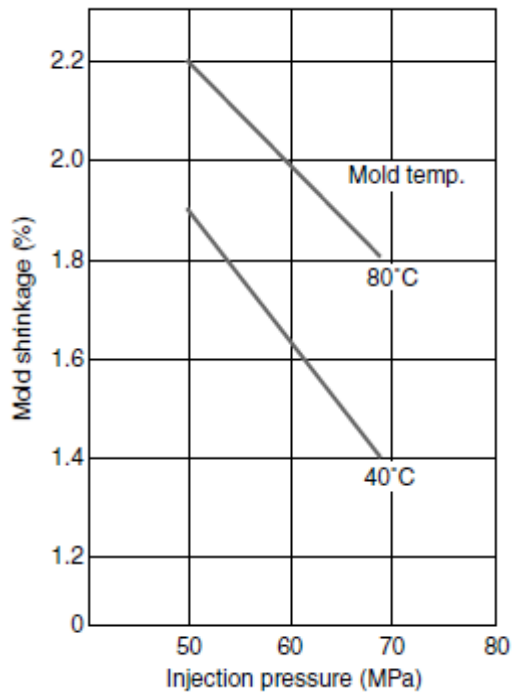
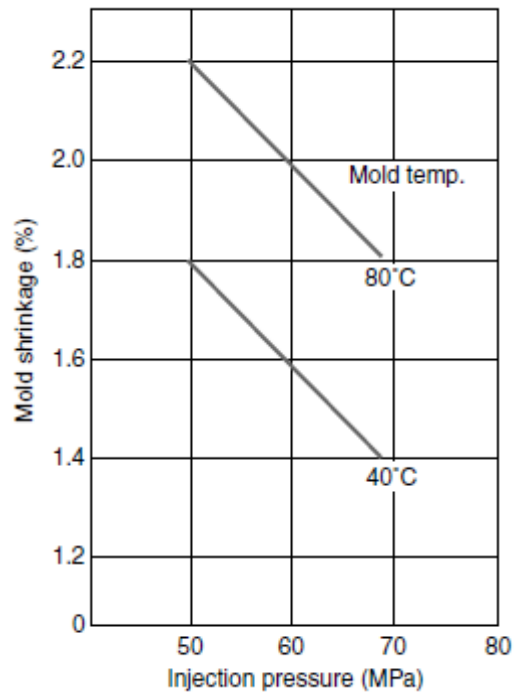

Fig. 2-11 DURACON® POM M450-44 mold shrinkage ratio (3mmt)



Processing parameters

- Material temp. : 185~190°C
- Mold temp. : 80, 40°C
- Injection speed : 67mm/sec
- Mold : 120×120×(2t, 3t) mm
- Gate : 4×2mm for 2mmt
6×3mm for 3mmt
- Cycle time : 2mmt Injection 20s, cooling 10s
3mmt Injection 25s, cooling 10s

2.3 Molding cycle

Through employing **M270-44**, a vastly contracted cycle time is achievable compared with **M90-44**. Very cost effective molding is therefore achievable. The following points can be considered as the reasons for this.

- (1) As flowability is good, the anisotropy in the mold shrinkage ratio is small, and therefore, molded products with small deformation and warpage can be achieved in a relatively short cooling time.
- (2) As flowability is good, the mold filling speed is fast, and injection time can therefore be shortened.
- (3) As flowability is good, sufficient mold filling is possible even with lower material and mold temperature. Therefore, the material can setup with a relatively short cooling time, upon which take out can be carried out.

Representative examples of cycle time shortening are introduced below.

[Example 1]

Name of molded part : flat disc (110mm x2mmt)
 Mold : single cavity, central pin gate.

Cycle-defining parameter: Surface variance around periphery is less than 0.3mm.

Material	DURACON® M90-44	DURACON® M270-44
Cylinder temperature	190°C	190°C
Mold temperature	80°C	80°C
Cycle Injection	12s	12s
Cooling*	20s	5s
Total	32s	17s

*refer to Figure 3-12

Fig. 2-12 Comparison of cooling times necessary to limit surface variance to within 0.3mm

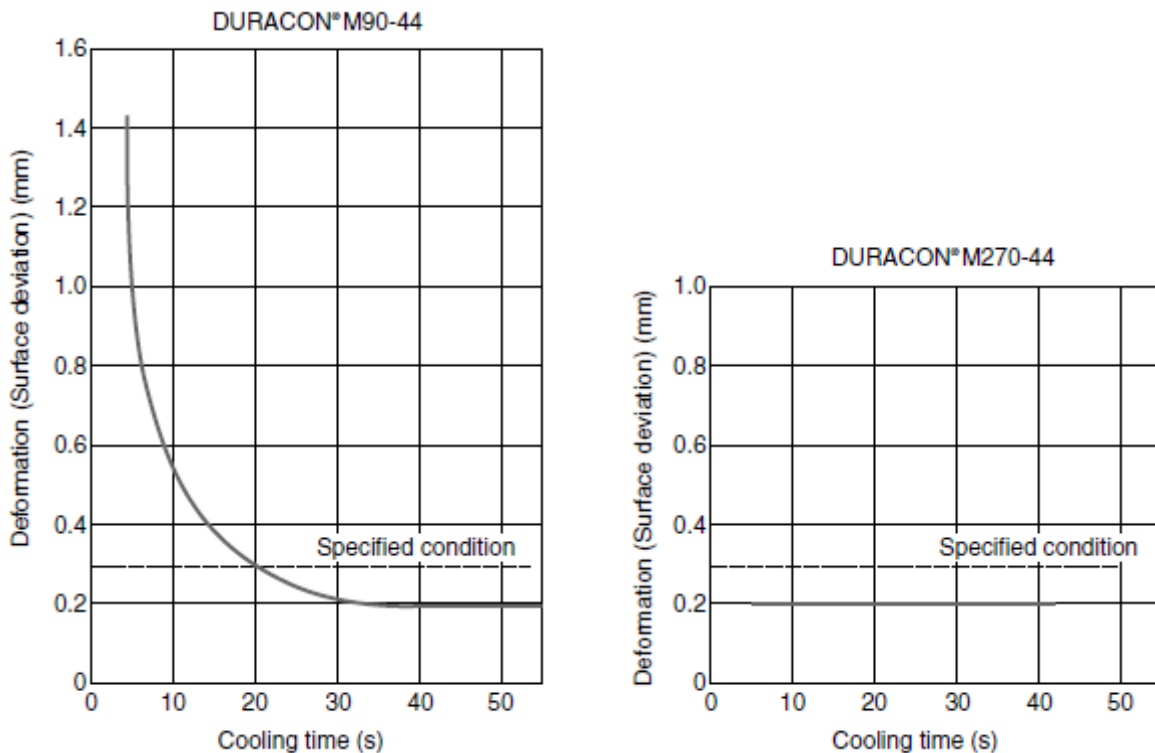

[Example 2]

Name of molded part : small component of complicated shape (6 g/part)

Mold : 8 cavity, central pin gate.

Cycle-defining parameter: Dimensions are within limits of specifications.

Material	DURACON® M90-44	DURACON® M270-44
Cylinder temperature	190°C	190°C
Mold temperature	70°C	50°C
Injection pressure	68MPa	68MPa
Cycle time (total)	40s	25s

[Example 3]

Name of molded part : stereo, tape, cartridge platform (thin flat disc)

Mold : 8 cavity

Cycle-defining parameter : Surface variance of less than 0.5mm

Material	DURACON® M140-44	DURACON® M270-44
Cylinder temperature	190°C	190°C
Mold temperature	40°C	55°C
Injection pressure	68MPa	68MPa
Cycle time (total)	20.5s	13.5s

[Example 4]

Name of molded part : felt-tip pen cap

Mold : 16 cavity

Cycle-defining parameter : Core pin overheating

Material	DURACON® M140-44	DURACON® M270-44
Cylinder temperature	190°C	190°C
Mold temperature	90°C	65°C
Injection pressure	98MPa	98MPa
Cycle time (total)	25s	13.5s

2.4 Reuse and stability while resident in molding machine

The heat stability of **M90-44** when being molded is excellent. **Table 2-5** shows the retention of properties for **M90-44** when it is repeatedly remolded, with **100%** of the material from the previous molding cycle recycled for the next cycle. As is recommended for other grades, is around **25-30%** of returned material is blended with virgin material, the resulting blend can be used with no problem. If anything, care should be exercised so as not to introduce any contaminants

when grinding returned material.

Test results for color change, which is often a problem caused by heat stability of material that is resident in the molding machine for extended

periods, are shown in **Table 2-6**. For practical molding parameters, color change is not a problem. Moreover, for cases where the residence

time in the molding machine is extended to the point where it is regarded to be a considerably severe condition, color change is not great.

However, color change is slightly larger than M90-02, so care is necessary. Moreover, at this degree of color change, there is no degradation in

terms of mechanical and physical properties.

Data

for **M270-44** is shown in **Table 2-7**.

Table 2-5 Property retention for DURACON® POM M90-44 under repeated molding

(Retention : %)

Number of recycling times	Properties	Tensile strength	Tensile elongation	Izod impact (with notch)	Change in hue (ΔE)
0		100	100	100	—
1		101	101	102	1.4
2		101	96	97	2.7
3		101	97	97	3.8
4		101	104	100	5.3
5		102	96	90	6.5

Note1: For change in hue, refer to Table 2-1.

Note2: Molding conditions nozzle

Cylinder temperature : 190-190-170-150°C

Mold temperature : 80°C

Injection speed : 17mm/sec

Table 2-6 Color change resulting from DURACON® POM M90-44 being resident in molding machine

(Degree of discoloration : ΔE)

Retention time(mim)	Cylinder temperature(°C)		
	190	200	210
15	0.3	0.5	0.4
30	0.5	0.9	0.8
45	0.6	0.8	1.4
60	0.7	1.2	3.4

Note : For ΔE showing degree of discoloration, refer to Table 2-2.

Table 2-7 Property changes resulting from repeated molding of DURACON® POM M270-44

Property		Unit	New pellet	Reusing for five times
Tensile property	Yield strength	MPa	60	57
	Elongation at yield	%	12	12
	Break strength	MPa	54	51
	Elongation at break	%	40	40
	Modulus of elasticity	MPa	2,820	2,820
Flexural property	Flexural strength	MPa	96	96
	Flexural modulus	MPa	2,580	2,580
Izod impact strength (notched)		J/m	52	52
Vicat softening point		°C	162	162

NOTES TO USERS

- All property values shown in this brochure are the typical values obtained under conditions prescribed by applicable standards and test methods.
- This brochure has been prepared based on our own experiences and laboratory test data, and therefore all data shown here are not always applicable to parts used under different conditions. We do not guarantee that these data are directly applicable to the application conditions of users and we ask each user to make his own decision on the application.
- It is the users' responsibility to investigate patent rights, service life and potentiality of applications introduced in this brochure. Materials we supply are not intended for the implant applications in the medical and dental fields, and therefore are not recommended for such uses.
- For all works done properly, it is advised to refer to appropriate technical catalogs for specific material processing.
- For safe handling of materials we supply, it is advised to refer to the Safety Data Sheet "SDS" of the proper material.
- This brochure is edited based on reference literature, information and data available to us at the time of creation. The contents of this brochure are subject to change without notice upon achievement of new data.
- Please contact our office for any questions about products we supply, descriptive literatures or any description in this brochure.

DURACON® is a registered trademark of Polyplastics Co., Ltd. in Japan and other countries.

POLYPLASTICS CO., LTD.

JR Shinagawa East Bldg.,
18-1, Konan 2-chome, Minato-ku, Tokyo, 108-8280 Japan
Tel: +81-3-6711-8610 Fax: +81-3-6711-8618

<http://www.polyplastics.com/en/>